

www.ersatzteil-service.de

www.ersatzteilplan.de

IBEA

Modello n.	Serie dal n.
IB-4221F	001
IB-4233F	001
IB-4235F	001
IB-4237F	001
IB-4238F	001

Stampato n. P5090169

LISTA RICAMBI

SPARE PARTS LIST

ERSATZTEILLISTE

LISTE DES PIECES DE RECHANGE



SERIE 420 A RULLO

[Ihr Ersatzteilspezialist im Internet](#)

REF. N°	PART. N°	QTY	DESCRIZIONE	DESCRIPTION	DESCRIPTION	BESCHREIBUNG
1	P5140334	1	DECALCO	DECAL	MARQUAGE	AUFKLEBER
2	P5140552	1	DECALCO	DECAL	MARQUAGE	AUFKLEBER
3	P5140573	1	DECALCO	DECAL	MARQUAGE	AUFKLEBER
4	P5140574	1	DECALCO	DECAL	MARQUAGE	AUFKLEBER
5	P5140138	2	DECALCO	DECAL	MARQUAGE	AUFKLEBER
6	P5140337	1	DECALCO	DECAL	MARQUAGE	AUFKLEBER
7	P5140558	1	DECALCO	DECAL	MARQUAGE	AUFKLEBER
8	P5140531	1	DECALCO	DECAL	MARQUAGE	AUFKLEBER
9	P5140536	1	DECALCO	DECAL	MARQUAGE	AUFKLEBER
10	P5140537	1	DECALCO	DECAL	MARQUAGE	AUFKLEBER
11	P5140109	1	DECALCO	DECAL	MARQUAGE	AUFKLEBER
12	P5140110	1	DECALCO	DECAL	MARQUAGE	AUFKLEBER
13	P5140334	1	DECALCO	DECAL	MARQUAGE	AUFKLEBER
14	P5110008	1	CHIAVE TUBO	KEY	CLEF	SCHLÜSSEL
15	P5090171	1	MANUALE ISTRUZIONI	INSTRUCTION MANUAL	MODE D'EMPLOI	BEDIENUNGSANLEITUNG

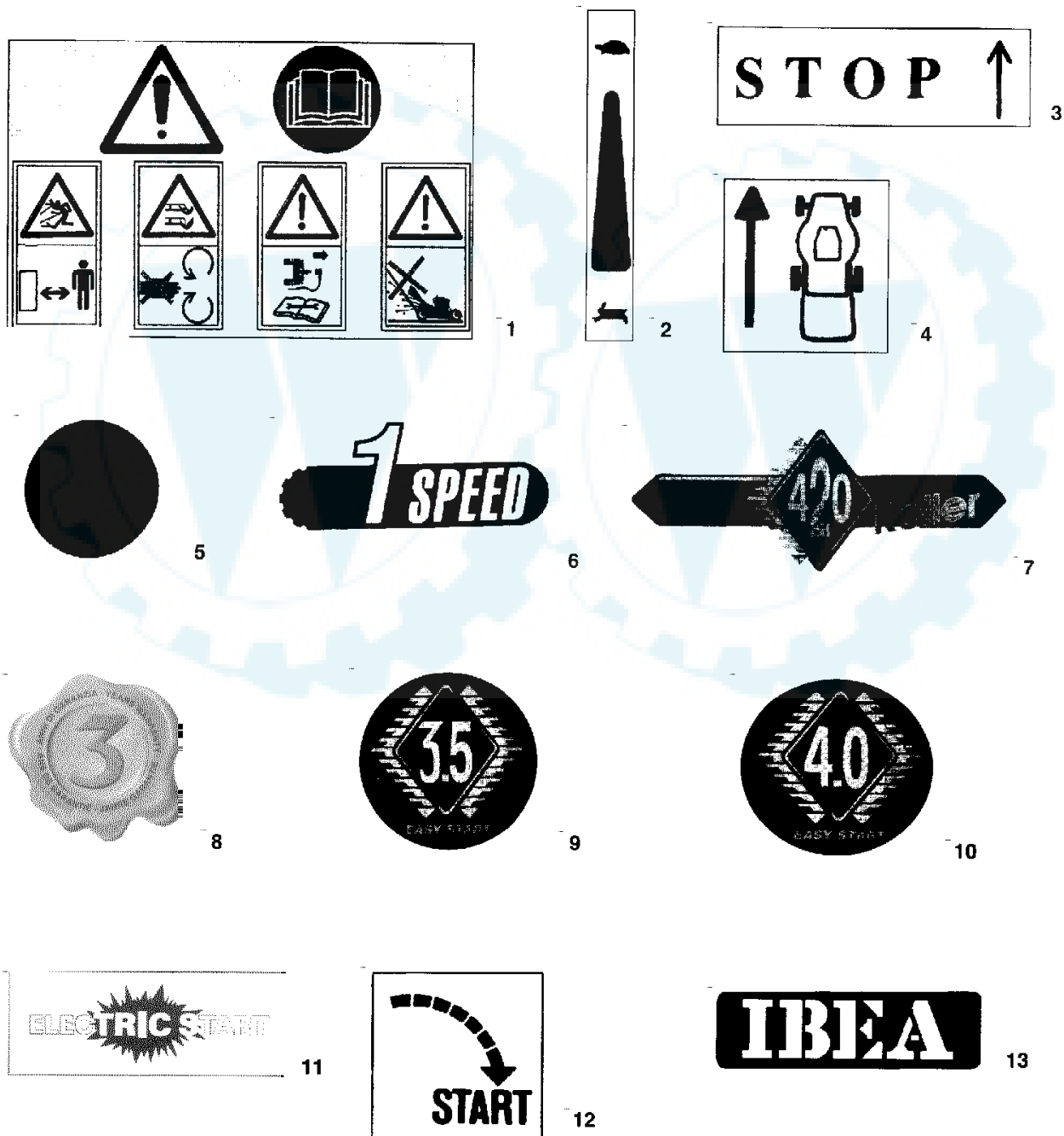

REF. N°	PART. N°	QTY	DESCRIZIONE	DESCRIPTION	DESCRIPTION	BESCHREIBUNG
	P01011056		TELAIO CESTELLO	BAG FRAME	CADRE	GESTELL
2	P3160013		SACCO RACCOGLIERBA	GRASS BAG	SAC DE RAMASSAGE	GRASFANGSACK
3	P00010056		CESTELLO COMPLETO	GRASS BAG ASS.Y	SAC DE RAMASSAGE COMPI	GRASFANGSACK KOMP.
4			MOTORE	ENGINE	MOTEUR	MOTOR
5	1090001A1		CHIAVETTA	KEY	CLAVETTE	SCHEIBENFEDER
6	P1050011	1	DADO	NUT	ÉCROU	MUTTER
7	P1010061	2	VITE	SCREW	VIS	SCHRAUBE
8	P2020089	1	CARTER COPRICINGHIA	BELT COVER	COUVERCLE DE COURROIRE	KEILRIEMENADBECKUNG
9	P1060004	2	FISSATORE	WASHER	RONDELLE	SCHIBE
10	P1010108	5	VITE	SCREW	VIS	SCHRAUBE
11	P1010109		VITE	SCREW	VIS	SCHRAUBE
12	P2020113		CARTER LATERALE	R.H. HOUSING	COUVERCLE DROITE	ABDECKUNG R.
13	P02005256	1	SCocca	DECK	CHÂSSIS	GEHÄUSE
14	P2020166	3	BUSSOLA	BUSHING	DOUILLE	BÜCHSE
15	1020009A1	3	RONDELLA	WASHER	RONDELLE	SCHIBE
16	P1020063	3	RONDELLA	WASHER	RONDELLE	SCHIBE
17	P1050011	2	DADO	NUT	ÉCROU	MUTTER
18	P1020080	3	RONDELLA	WASHER	RONDELLE	SCHIBE
19	P1010098	1	VITE	SCREW	VIS	SCHRAUBE
19	P1010101	2	VITE	SCREW	VIS	SCHRAUBE
20	P3040086	2	PERNO	PIN	GOUILLE	STIFT
21	P01030366	1	ASSALE ANTERIORE	FRONT AXLE	ESSIEU ANT.	FORDERACHSE
22	P2020077	1	POMELLO LEVA	KNOB	POIGNÉE	KNOPF
23	P00046066	1	LEVA ANTERIORE	FRONT LEVER	LEVIER ANT.	RADHEBEL
24	P01032156	1	PIASTRA	PLATE	PLAQUE	PLATTE
25	P1020064	2	RIVETTO	STUD	RIVET	NIET
26	P01032056	1	PIASTRA	PLATE	PLAQUE	PLATTE
27	P3040087	2	BUSSOLA	BUSHING	DOUILLE	BÜCHSE
28	P2020114	1	CARTER LATERALE	L.H. HOUSING	COUVERCLE GAUCHE	ABDECKUNG L.
29	P3020011	1	MOLLA	SPRING	RESSORT	FEDER
30	P01027066	1	ASTINA	ROD	TIGE	STAB
31	P2020109	1	PORTELLO	SHIELD	PROTECTION	SCHUTZ
32	P4050020	1	LAMA	BLADE	LAME	MESSER
33	1110002A1	1	MOLLA	SPRING	RESSORT	FEDER
34	P1010128	1	VITE LAMA	BLADE SCREW	VIS DE COUTEAU	MESSERSCHRAUBE
35	P1020067	1	RONDELLA	WASHER	RONDELLE	SCHIBE
36	2020050A1	2	POMELLO	KNOB	POIGNÉE	MUTTER
37	P3040099	1	DISTANZIALE	SPACER	DOUILLE	DISTANZBÜCHSE
38A	P3040253	1	BUSSOLA LAMA, A SPINTA	BLADE BUSHING, PUSH MODEL	DOUILLE DE LAME, MOD. POUSSÉ	MESSERBÜCHSE, HANDGESTOßEN MODEL
38B	P3040102	1	BUSSOLA LAMA, SEMOVENTE	BLADE BUSHING, SELF-PROP. MODEL	DOUILLE DE LAME, MODÈLE TRACTÉ	MESSERBÜCHSE, MODEL MIT RADANTR.
39A			PER 4237F/4221F/4238F	FOR 4237F/4221F/4238F	POUR 4237F/4221F/4238F	FÜR 4237F/4221F/4238F
39B			PER 4233F/4235F	FOR 4233F/4235F	POUR 4233F/4235F	FÜR 4233F/4235F
40	P1020060	2	RONDELLA	SPRING WASHER	RONDELLE ÉLASTIQUE	FEDERSCHIBE
41	P2020088	2	DISTANZIALE	SPACER	RONDELLE	DISTANZBÜCHSE
42	P2020377	2	COPRIRUOTA	WHEEL COVER	COUVERCLE DE ROUE	RADABDECKUNG
43	P3030013	4	CUSCINETTO	BEARING	PALIER	LAGER
44	P2020378	2	CERCHIONE	HUB	JANTE	FELGE
45	P2020078	2	COPERTONE	TYRE	PNEU	REIFEN
46	P2080002	2	RUOTA	WHEEL ASS.Y	ROUE COMPL.	RAD KOMP.
47	1020007A1	2	RONDELLA	WASHER	RONDELLE	SCHIBE
48	1010018A1	2	VITE	SCREW	VIS	SCHRAUBE
49	P2020062	2	COPRIMOZZO	COVER	COUVERCLE	DECKEL
50	P2020088	2	DISTANZIALE	SPACER	RONDELLE	DISTANZBÜCHSE
51	1020007A1	2	RONDELLA	WASHER	RONDELLE	SCHIBE
52	1010018A1	2	VITE	SCREW	VIS	SCHRAUBE
53	P2020220	2	COPRIMOZZO	WHEEL COVER	COUVERCLE DE ROUE	RADABDECKUNG
54	P2020213	2	RUOTA	WHEEL	ROUE	RAD
55	1020014A1	2	RONDELLA	WASHER	RONDELLE	SCHIBE
56	P2020117	2	GALLETTO	KNOB	POIGNÉE	MUTTER
57	1010026A1	2	VITE	SCREW	VIS	SCHRAUBE
58	P02070257	2	STEGOLA INF.	LOWER HANDLEBAR	GUIDON INF.	LENKERUNTERTEIL
59	P2020165	1	CAPOTTINA	ENGINE COVER	COUVERCLE MOTEUR	MOTORABDECKUNG
60	P1010154	1	VITE	SCREW	VIS	SCHRAUBE

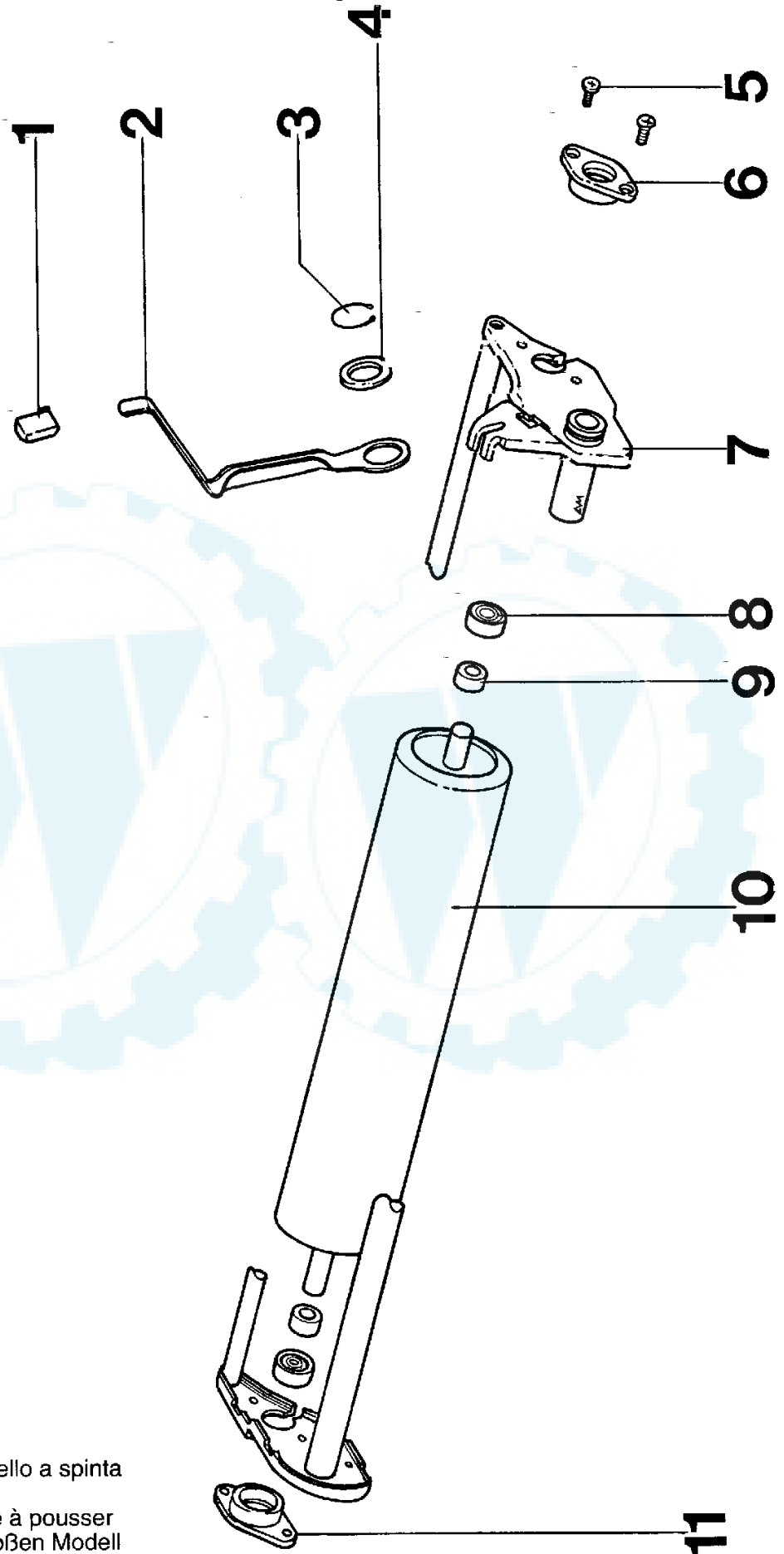

Tav. 2

Assale posteriore, modello a spinta
Rear axle, push model
Essieux arrière, modèle à pousser
Hinterachse, handgestoßen Modell

www.ersatzteil-service.de

www.ersatzteilplan.de

REF. N°	PART. N°	QTY	DESCRIZIONE	DESCRIPTION	DESCRIPTION	BESCHREIBUNG
1	P0020077	1	POMELLO	KNOB	POIGNÉE	KNOF
2	P00066166	1	LEVA.PEZZE.NR.38	REAR LEVER	LEVIER ARRIERE	RADHEBEL
3	P1070008	1	SEGER	CIRCLIP	SEGER	SEGER
4	P1020050	1	BONDELLA	SPACER	DOILLE	ABSTANDSTÜCK
5	P1010070	4	VITE	SCREW	VI	SCHRAUBE
6	P2020111	1	SUPPORTO CUSCINETTO	BEARING SUPPORT	SUPPORT DE ROULEMENT	HALTER
7	P01028059	1	SUPPORTO RULLO	ROLLER MOUNTING	SUPPORT DE ROULEAU	HALTER
8	P2100115	2	CUSCINETTO	BEARING	ROLER	LAGER
9	P0340105	2	DISTANZALE	SPACER	ENTRETOISE	DISTANZRING
10	P01011059	1	RULLO	ROLLER	ROULEAU	ROLLE
11	P2020110	1	SUPPORTO CUSCINETTO	BEARING SUPPORT	SUPPORT DE ROULEMENT	HALTER

Ihr Ersatzteilspezialist im Internet

Tav. 3

Assale posteriore e trasmissione, modello a trazione
Rear axle and gear box, self-propelled model
Essieux arrière et transmission, modèle tracté
Hinterachse und Getriebe, Modell mit Radantrieb

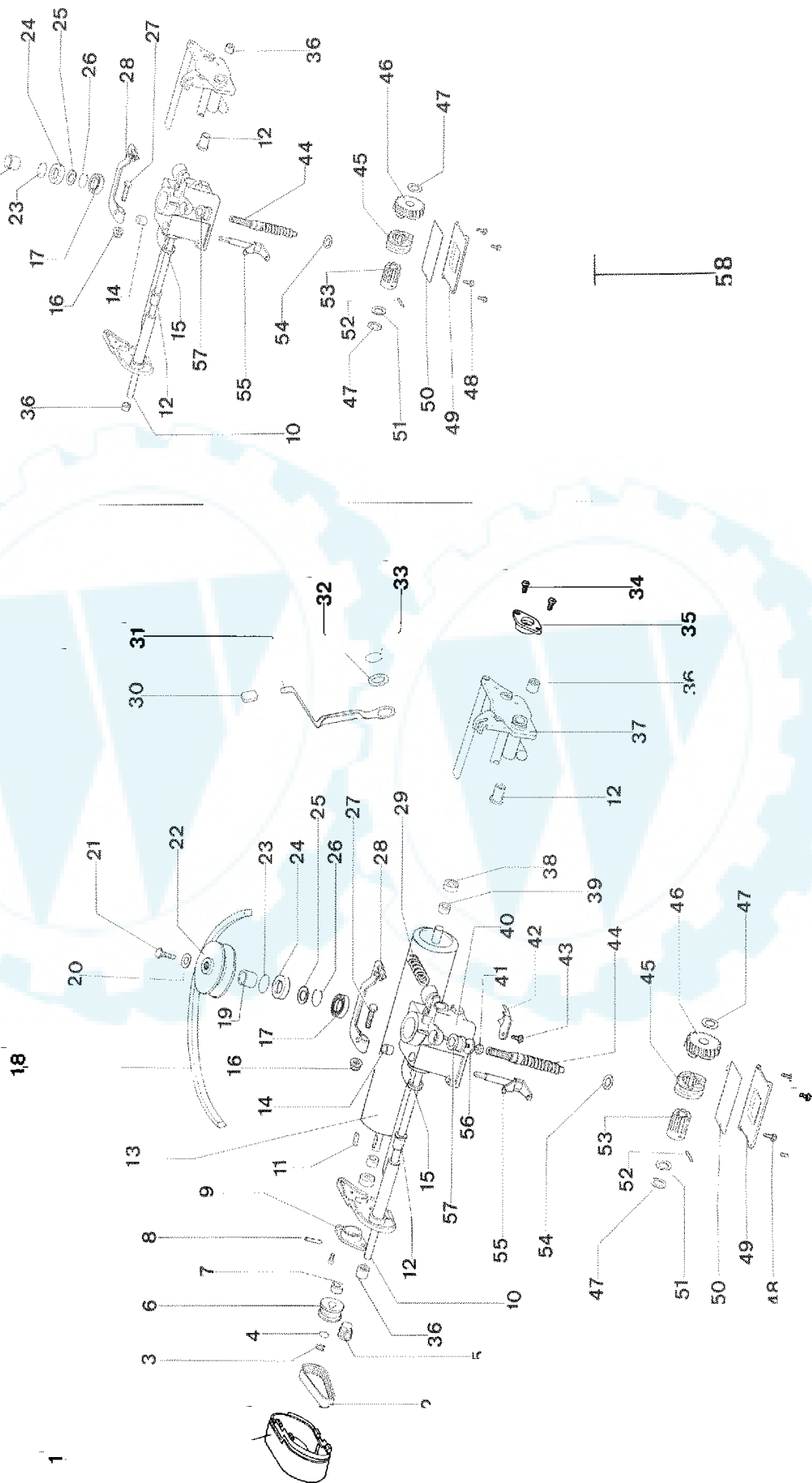

REF. N°	PART. N°	QTY	DESCRIZIONE	DESCRIPTION	DESCRIPTION	BESCHREIBUNG
1	P3060053		CARTER	COVER	COUVERCLE	ADBECKUNG
2	P3010028		CINGHIA	BELT	CORROIRE	RIEMEN
3	1070001A1		SEEGER	CIRCLIP	SEEGER	SEEGER
4	1020020A1		RONDELLA	WASHER	RONDELLE	SCHEIBE
5	P3040303		PULEGGIA	PULLEY	POULIE	RIEMENSCHLEIBE
6	P3040302	1	PULEGGIA	PULLEY	POULIE	RIEMENSCHLEIBE
7	P3040111	1	DISTANZIALE	SPACER	ENTRETOISE	DISTANZRING
8	P1080007	1	SPINA	PIN	GOUPILLE	STIFT
9	P2020110	1	SUPPORTO CUSCINETTO	BEARING SUPPORT	SUPPORT DE ROULEMENT	HALTER
10	P3040106	1	ALBERO TRAZIONE	TRACTION SHAFT	ARBRE DE TRACTION	ANTRIEBSWELLE
11	P1090004	1	CHIAVETTA	SPLINE	CLAVETTE	SCHIEBENFEDER
12	P2020070	2	BOCCOLA	BUSHING	DOUILLE	BÜCHSE
13	P01016060	1	RULLO	ROLLER	ROULEAU	ROLLE
14	P3170012	1	ANELLO DI TENUTA	OIL SEAL	JOINT D'ARBRE	WELLENDICHTRING
15	P3170011	2	ANELLO DE TENUTA	OIL SEAL	JOINT D'ARBRE	WELLENDICHTRING
16	1050003A1		DADO	NUT	ÉCROU	MUTTER
17	P3030010		CUSCINETTO	BEARING	PALIER	LAGER
18	P3010013		CINGHIA	BELT	COURROIE	RIEMEN
19	P3040049		BUSSOLA	BUSHING	DOUILLE	BÜCHSE
20	1020007A1		RONDELLA	WASHER	RONDELLE	SCHEIBE
21	1010018A1		VITE	SCREW	VIS	SCHRAUBE
22	P3040048		PULEGGIA	PULLEY	POULIE	RIEMENSCHLEIBE
23	P3170013		O-RING	SPACER	DOUILLE	ABSTANDSSTÜCK
24	P3170010		ANELLO DI TENUTA	OIL SEAL	JOINT D'ARBRE	WELLENDICHTRING
25	P1020051		RONDELLA	WASHER	RONDELLE	SCHEIBE
26	P1070004		SEEGER	CIRCLIP	SEEGER	SEEGER
27	P1010075		VITE	SCREW	VIS	SCHRAUBE
28	P4070011		LEVA TRAZIONE	LEVER	LEVIER	HEBEL
29	P3020010		MOLLA	SPRING	RESSORT	FEDER
30	P2020077		POMELLO	KNOB	POIGNÉE	KNOPF
31	P00046166		LEVA POSTERIORE	REAR LEVER	LEVIER ARRIÈRE	RADHEBEL
32	P1020058		RONDELLA	SPACER	DOUILLE	ABSTANDSSTÜCK
33	P1070008	1	SEEGER	CIRCLIP	SEEGER	SEEGER
34	P1010070	4	VITE	SCREW	VIS	SCHRAUBE
35	P2020111	1	SUPPORTO CUSCINETTO	BEARING SUPPORT	SUPPORT DE ROULEMENT	HALTER
36	3030003A1	2	CUSCINETTO	BEARING	PALIER	LAGER
37	P01028060	1	SUPPORTO RULLO	ROLLER MOUNTING	SUPPORT DE ROULEAU	HALTER
38	P3030015	2	CUSCINETTO	BEARING	PALIER	LAGER
39	P3040105	2	DISTANZIALE	SPACER	ENTRETOISE	DISTANZRING
40	P00039199		SCATOLA RIDUTTORE	GEARBOX HOUSING	BOÎTE DE VITESSE	GETRIEBE
41	P1010104		VITE	SCREW	VIS	SCHRAUBE
42	P4030010		COPERCHIETTO	COVER	COUVERCLE	DECKEL
43	P1010076		VITE	SCREW	VIS	SCHRAUBE
44	P3040042		VITE SENZA FINE	WORM GEAR	VIS SANS FIN	SCHNECKE
45	P00038099	1	INNESTO	SELECTOR COLLAR	MANCHON	SCHALTBÜCHSE
46	P00038199	1	RUOTA ELICOIDALE	WORM WHEEL	ROUE POUR VIS S. FIN	SCHNECKENRAD
47	1020020A1	2	RONDELLA	WASHER	RONDELLE	SCHEIBE
48	P1010076	4	VITE	SCREW	VIS	SCHRAUBE
49	P4110001	1	COPERCHIO	COVER	COUVERCLE	DECKEL
50	P3170014	1	O-RING	O-RING	JOINT TORIQUE	GUMMIRING
51	P1020051		RONDELLA	WASHER	RONDELLE	SCHEIBE
52	P1080007		SPINA	PIN	GOUPILLE	STIFT
53	P3050030		BUSSOLA	BUSHING	DOUILLE CANNELÉE	KEILHÜLSE
54	P1020054		RONDELLA	WASHER	RONDELLE	SCHEIBE
55	P3040041		FORCELLA	FORK	FOURCHE	GABEL
56	P1020054		RONDELLA	WASHER	RONDELLE	SCHEIBE
57	P2040010		ANTIVIBRANTE	RUBBER TUBE	TUBE DE PROTECTION	SCHUTZHÜLLE
58	P2090006		RIDUTTORE COMPLETO	GEARBOX ASS.Y	RÉDUCTEUR COMPL.	FAHRGETRIEBE KOMP.

Tav. 4

Stegola superiore e comandi, modello a spinta IB-4233F

Upper handle and controls, push model IB-4233F

Guidon supérieur et éléments de commande, modèle à pousser IB-4233F

Lenkeroberteil und Bedienungselemente, handgestoßen Modell IB-4233F

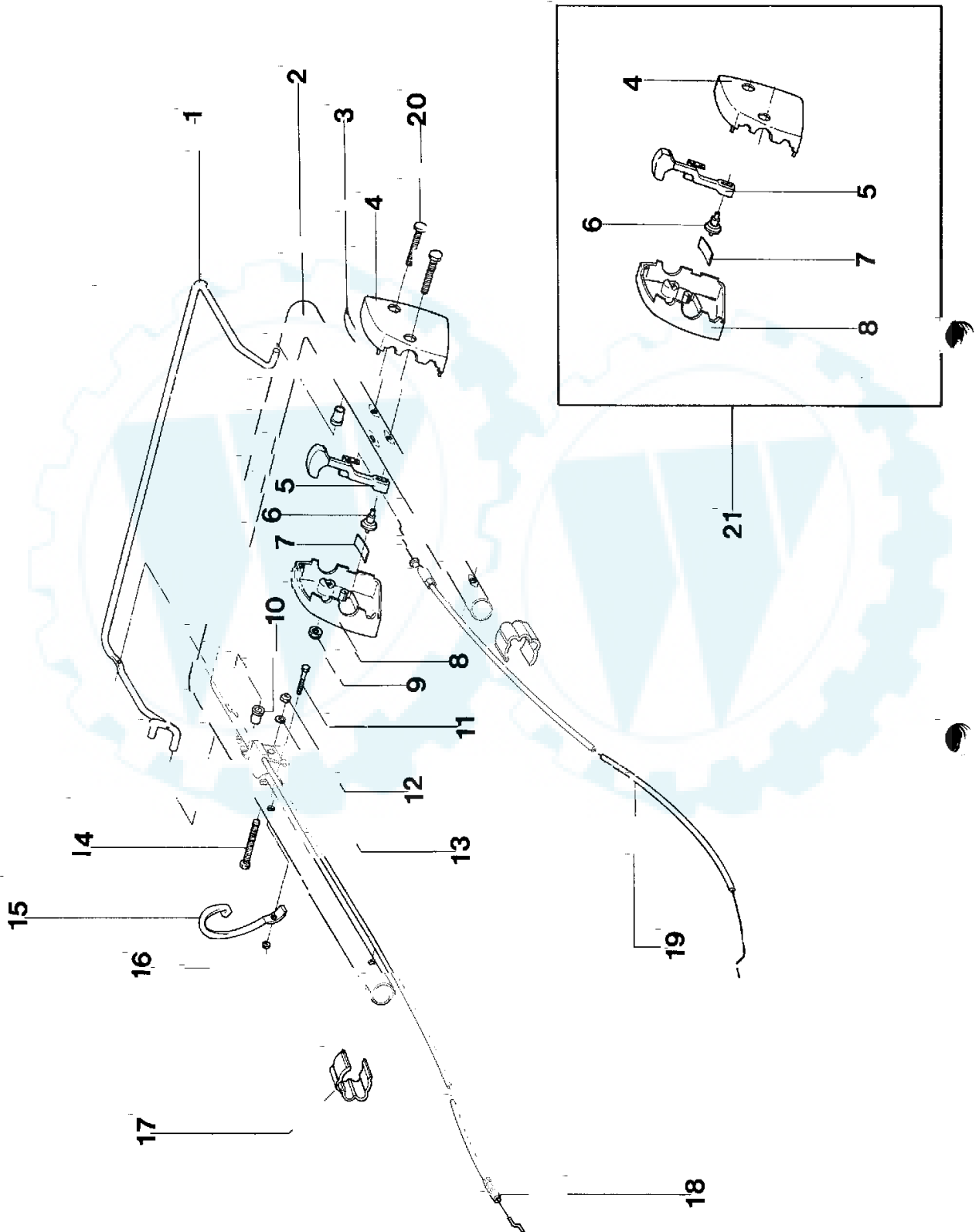

www.ersatzteil-service.de

www.ersatzteilplan.de

REF. N°	PART. N°	QTY	DESCRIZIONE	DESCRIPTION	DESCRIPTION	BESCHREIBUNG
1	P3060038VE		LEVA SYSTEM 2	SYSTEM 2 LEVER	LEVIER SYSTEM 2	SYSTEM 2 HEBEL
2	P3120091VE	1	STEGOLA SUPERIORE	UPPER HANDLEBAR	GUIDON SUPÉRIEUR	OB. FÜHRUNGSHOLM
3	P5140552	1	DECALCO ACCELER.	DECAL	MARQUAGE	AUFKLEBER
4	P2020107	1	SCATOLA ACCELER. SX	L. H. HOUSING	BOÎTE GAUCHE	SCHALE L.
5	P00065099	1	LEVA ACCELERATORE	THROTTLE LEVER	LEVIER DE COMMANDE	GASHEBEL
6	P2020108	1	NOTTOLINO	BOLT	BOULON	STIFT
7	P4010059	2	MOLLA	SPRING	RESSORT	FEDER
8	P2020106	1	SCATOLA ACC. DX	R.H. HOUSING	BOÎTE DROITE	SCHALE R.
9	1050003A1	2	DADO	NUT	ÉCROU	MUTTER
10	P3040123	2	BUSSOLA	BUSHING	DOUILLE	BÜCHSE
11	P1010065		VITE	SCREW	VIS	SCHRAUBE
12	1050003A1		DADO	NUT	ÉCROU	MUTTER
13	1020013A1	1	RONDELLA	WASHER	RONDELLE	SCHLEIBE
14	P1010203	1	VITE	SCREW	VIS	SCHRAUBE
15	P01068343	1	SUPPORTO A RICCIOLIO	STARTER HOLDER	SUPPORT	HALTER
16	1050002A1	1	DADO	NUT	ÉCROU	MUTTER
17	P2020080	2	FERMA CAVO	CLIP	CLIP	HALTER
18	P5010045		CAVO SYSTEM 2	SYSTEM 2 CABLE	CÂBLE SYSTEM 2	SYSTEM 2 KABEL
19	P5020027		CAVO ACCELERATORE	THROTTLE CABLE	CÂBLE DE GAZ	GASKABEL
20	P1010102	2	VITE	SCREW	VIS	SCHRAUBE
21	P00035099	1	SCATOLA ACC. COMPL.	THROTTLE HOUSING ASS. Y	BOÎTE DE GAZ COMPL.	GASGEHÄUSE KOMPL.

Ihr Ersatzteilspezialist im Internet

Tav. 5

Stegola superiore e comandi, modello a trazione IB-4235F
Upper handle and controls, self-propelled model IB-4235F
Guidon supérieur et éléments de commande, modèle tracté IB-4235F
Lenkeroberteil und Bedienungselemente, Modell mit Radantrieb IB-4235F

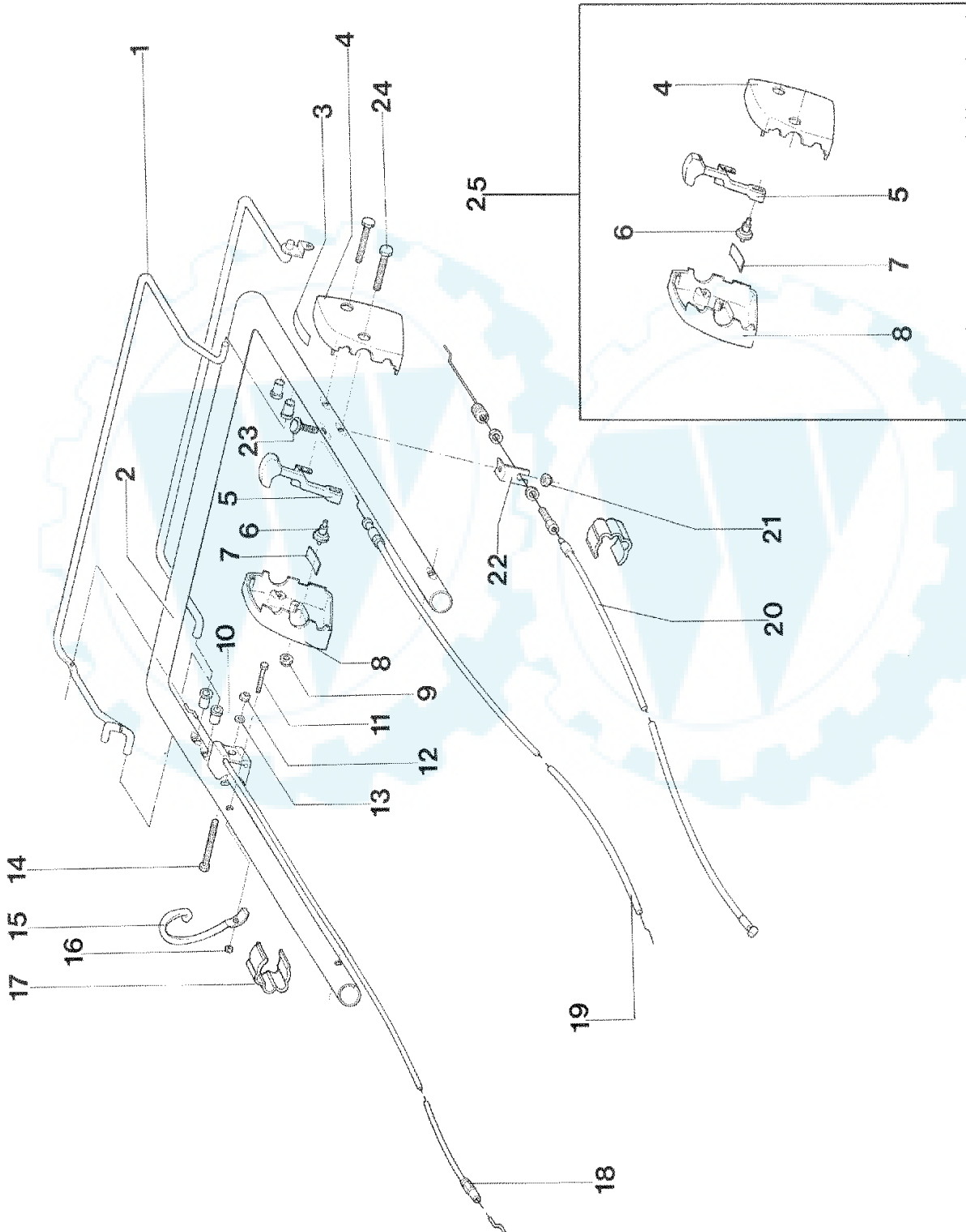

REF. N°	PART. N°	QTY	DESCRIZIONE	DESCRIPTION	DESCRIPTION	BESCHREIBUNG
1	P3060038VE	1	LEVA SYSTEM 2	SYSTEM 2 LEVER	LEVIER SYSTEM 2	SYSTEM 2 HEBEL
2	P3120091VE	1	STEGOLA SUPERIORE	UPPER HANDLEBAR	GUIDON SUPÉRIEUR	OB. FÜHRUNGSHOLM
3	P5140552	1	DECALCO ACCELER.	DECAL	MARQUAGE	AUFKLEBER
4	P2020107	1	SCATOLA ACCELER. SX	L. H. HOUSING	BOÎTE GAUCHE	SCHALE L.
5	P00065099	1	LEVA ACCELERATORE	THROTTLE LEVER	LEVIER DE COMMANDE	GASHEBEL
6	P2020108	1	NOTTOLINO	BOLT	BOULON	STIFT
7	P4010059	2	MOLLA	SPRING	RESSORT	FEDER
8	P2020106	1	SCATOLA ACC. DX	R.H. HOUSING	BOÎTE DROITE	SCHALE R.
9	1050003A1	2	DADO	NUT	ÉCROU	MÜTTER
10	P3040123	4	BUSSOLA	BUSHING	DOUILLE	BÜCHSE
11	P1010065	1	VITE	SCREW	VIS	SCHRAUBE
12	1050003A1	1	DADO	NUT	ÉCROU	MÜTTER
13	1020013A1	1	RONDELLA	WASHER	RONDELLE	SCHLEIBE
14	P1010203	1	VITE	SCREW	VIS	SCHRAUBE
15	P01068343	1	SUPPORTO A RICCIOLIO	STARTER HOLDER	SUPPORT	HALTER
16	1050002A1	1	DADO	NUT	ÉCROU	MÜTTER
17	P2020080	3	FERMA CAVO	CLIP	CLIP	HALTER
18	P5010045	1	CAVO SYSTEM 2	SYSTEM 2 CABLE	CÂBLE SYSTEM 2	SYSTEM 2 KABEL
19	P5020027	1	CAVO ACCELERATORE	THROTTLE CABLE	CÂBLE DE GAZ	GASKABEL
20	P5010030	1	CAVO TRAZIONE	TRACTION CABLE	CÂBLE DE TRACTION	ANTRIEBSKABEL
21	1050003A1	1	DADO	NUT	ÉCROU	MÜTTER
22	P4010060	1	PIASTRINA	PLATE	PLAQUE	PLATTE
23	P1010078	1	VITE	SCREW	VIS	SCHRAUBE
24	P1010102	2	VITE	SCREW	VIS	SCHRAUBE
25	P00035099	1	SCATOLA ACC. COMPL.	THROTTLE HOUSING ASS. Y	BOÎTE DE GAZ COMPL.	GASGEHÄUSE KOMPL.

Tav. 6

Stegola superiore e comandi, modello a spinta IB-4221F

Upper handle and controls, push model IB-4221F

Guidon supérieur et éléments de commande, modèle à pousser IB-4221F

Lenkeroberteil und Bedienungselemente, handgestoßen Modell IB-4221F

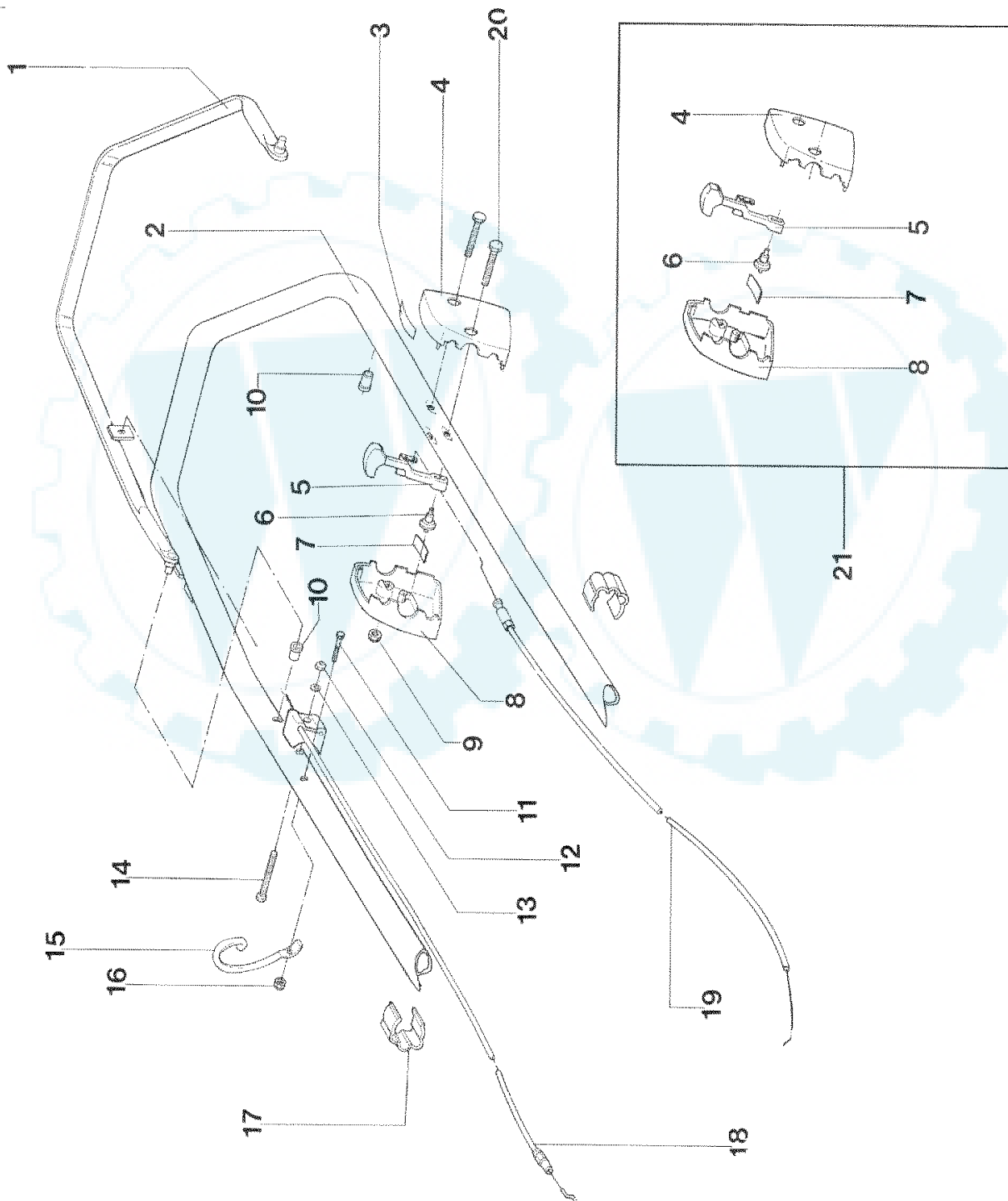

www.ersatzteil-service.de

www.ersatzteilplan.de

REF. N°	PART. N°	QTY	DESCRIZIONE	DESCRIPTION	DESCRIPTION	BESCHREIBUNG
1	P4080038VE		MANIGLIA SYSTEM 2	SYSTEM 2 LEVER	LEVIER SYSTEM 2	SYSTEM 2 HEBEL
2	P3120103VE		STEGOLA SUPERIORE	UPPER HANDLE BAR	GUIDON SUPÉRIEUR	OB. FÜHRUNGSHOLM
3	P5140552		DECALCO ACCELER.	DECAL	MARQUAGE	AUFKLEBER
4	P2020107		SCATOLA ACCELER. SX	L. H. HOUSING	BOÎTE GAUCHE	SCHALE L.
5	P00065099		LEVA ACCELERATORE	THROTTLE LEVER	LEVIER DE COMMANDE	GASHEBEL
6	P2020108	1	NOTTOLINO	BOLT	BOULON	STIFT
7	P4010059	2	MOLLA	SPRING	RESSORT	FEDER
8	P2020106	1	SCATOLA ACC. DX	R.H. HOUSING	BOÎTE DROITE	SCHALE R.
9	1050003A1	2	DADO	NUT	ÉCROU	MUTTER
10	P2020153	2	BUSSOLA	BUSHING	DOUILLE	BÜCHSE
11	P1010065	1	VITE	SCREW	VIS	SCHRAUBE
12	1050003A1	1	DADO	NUT	ÉCROU	MUTTER
13	1020013A1	1	RONDELLA	WASHER	RONDELLE	SCHEIBE
14	P1010203	1	VITE	SCREW	VIS	SCHRAUBE
15	P01068343	1	SUPPORTO A RICCIOLO	STARTER HOLDER	SUPPORT	HALTER
16	1050002A1		DADO	NUT	ÉCROU	MUTTER
17	P2020080	2	FERMA CAVO	CLIP	CLIP	HALTER
18	P5010059	1	CAVO SYSTEM 2	SYSTEM 2 CABLE	CÂBLE SYSTEM 2	SYSTEM 2 KABEL
19	P5020032		CAVO ACCELERATORE	THROTTLE CABLE	CÂBLE DE GAZ	GASKABEL
20	P1010102	2	VITE	SCREW	VIS	SCHRAUBE
21	P00035099		SCATOLA ACC. COMPL.	THROTTLE HOUSING ASS. Y	BOÎTE DE GAZ COMPL.	GASGEHÄUSE KOMPL.

Ihr Ersatzteilspezialist im Internet

Tav. 7

Stegola superiore e comandi, modello a trazione IB-4237F
Upper handle and controls, self-propelled model IB-4237F
Guidon supérieur et éléments de commande, modèle tracté IB-4237F
Lenkeroberteil und Bedienungselemente, Modell mit Radantrieb IB-4237F

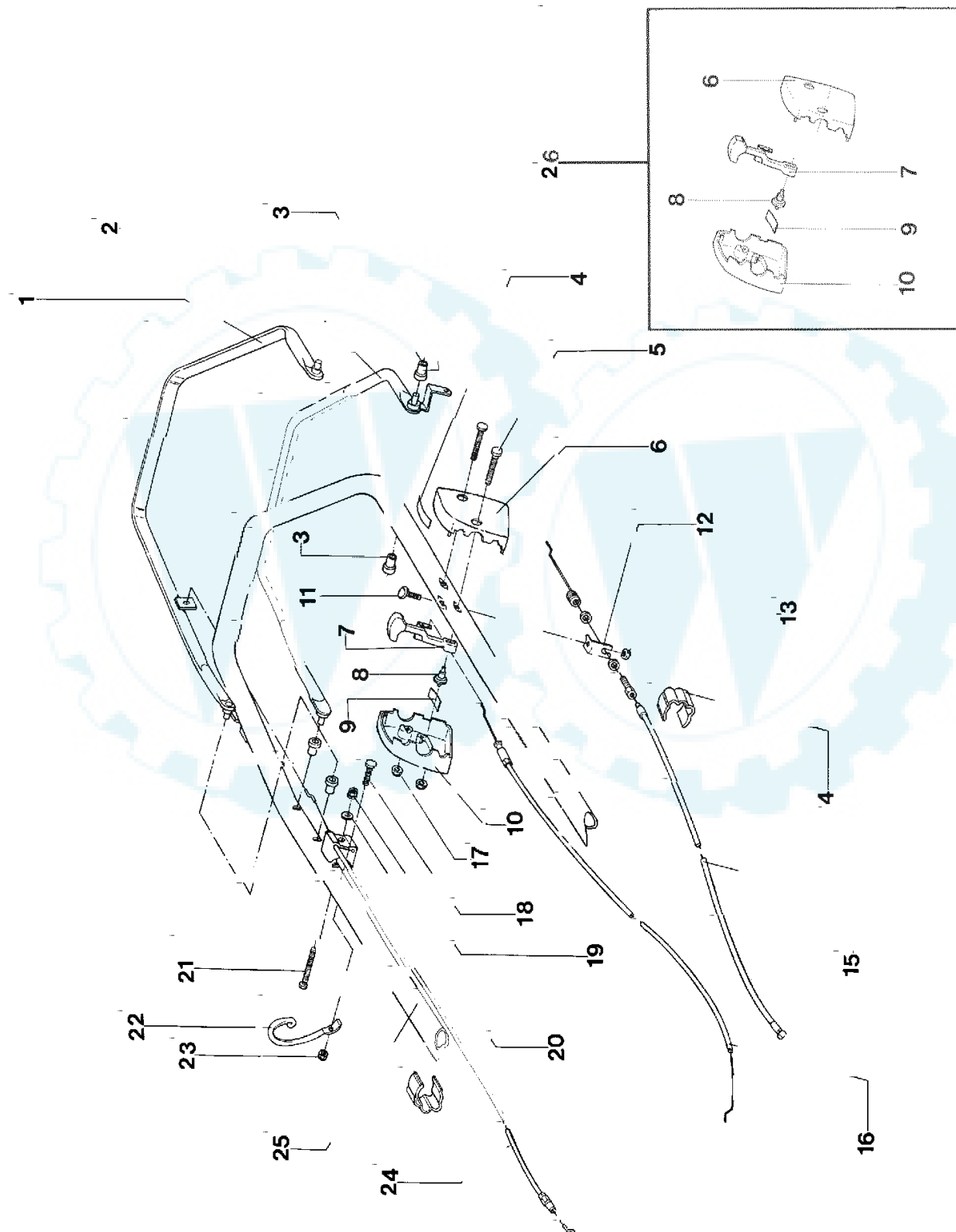

www.ersatzteil-service.de

www.ersatzteilplan.de

REF. N°	PART. N°	QTY	DESCRIZIONE	DESCRIPTION	DESCRIPTION	BESCHREIBUNG
1	P3060038VE	1	MANIGLIA SYSTEM 2	SYSTEM 2 LEVER	LEVIER SYSTEM 2	SYSTEM 2 HEBEL
2	P02042181	1	MANIGLIA TRAZIONE	TRACTION LEVER	POIGNÉE DE TRACTION	ANTRIEBSHEBEL
3	P2020153	4	BUSSOLA	BUSHING	DOUILLE	BÜCHSE
4	P5140552	1	DECALCO ACCELER.	DECAL	MARQUAGE	AUFKLEBER
5	P1010102	2	VITE	SCREW	VIS	SCHRAUBE
6	P2020107	1	SCATOLA ACCELER. SX	L. H. HOUSING	BOÎTE GAUCHE	SCHALE L.
7	P00065099	1	LEVA ACCELERATORE	THROTTLE LEVER	LEVIER DE COMMANDE	GASHEBEL
8	P2020108	1	NOITOLINO	BOLI	BOULON	STIFT
9	P4010069	2	MOLLA	SPRING	RESSORT	FEDER
10	P2020106	1	SCATOLA ACC. DX	R.H. HOUSING	BOÎTE DROITE	SCHALE R.
11	P1010078	1	VITE	SCREW	VIS	SCHRAUBE
12	P4010060	1	PIASTRINA	PLATE	PLAQUE	PLATTE
13	1050003A1	1	DADO	NUT	ÉCROU	MUTTER
14	P2020080	3	FERMA CAVO	CLIP	CLIP	HALTER
15	P5010030	1	CAVO TRAZIONE	TRACTION CABLE	CÂBLE DE TRACTION	ANTRIEBSKABEL
16	P5020032	1	CAVO ACCELERATORE	THROTTLE CABLE	CÂBLE DE GAZ	GASKABEL
17	1050003A1	2	DADO	NUT	ÉCROU	MUTTER
18	P1010065	1	VITE	SCREW	VIS	SCHRAUBE
19	1050003A1	1	DADO	NUT	ÉCROU	MUTTER
20	1020013A1	1	RONDELLA	WASHER	RONDELLE	SCHEIBE
21	P1010203	1	VITE	SCREW	VIS	SCHRAUBE
22	PO1068343	1	SUPPORTO A RICCIOLIO	STARTER HOLDER	SUPPORT	HALTER
23	1050002A1	1	DADO	NUT	ÉCROU	MUTTER
24	P5010069	1	CAVO SYSTEM 2	SYSTEM 2 CABLE	CÂBLE SYSTEM 2	SYSTEM 2 KABEL
25	P3120103VE	1	STEGOLA SUP.	UPPER HANDLE BAR	GUIDON SUP.	OB. FÜHRUNGSHOLM
26	P00035099	1	SCATOLA ACC. COMPL.	THROTTLE HOUSING ASS. Y	BOÎTE DE GAZ COMPL.	GASGEHÄUSE KOMPL.

Ihr Ersatzteilspezialist im Internet

Tav. 8

Stegola superiore e comandi, modello a trazione electric start IB-4238F
Upper handle and controls, self-propelled model electric start IB-4238F
Guidon supérieur et éléments de commande, modèle tracté electric start IB-4238F
Lenkeroberteil und Bedienungselemente, Modell mit Radantrieb electric start IB-4238F

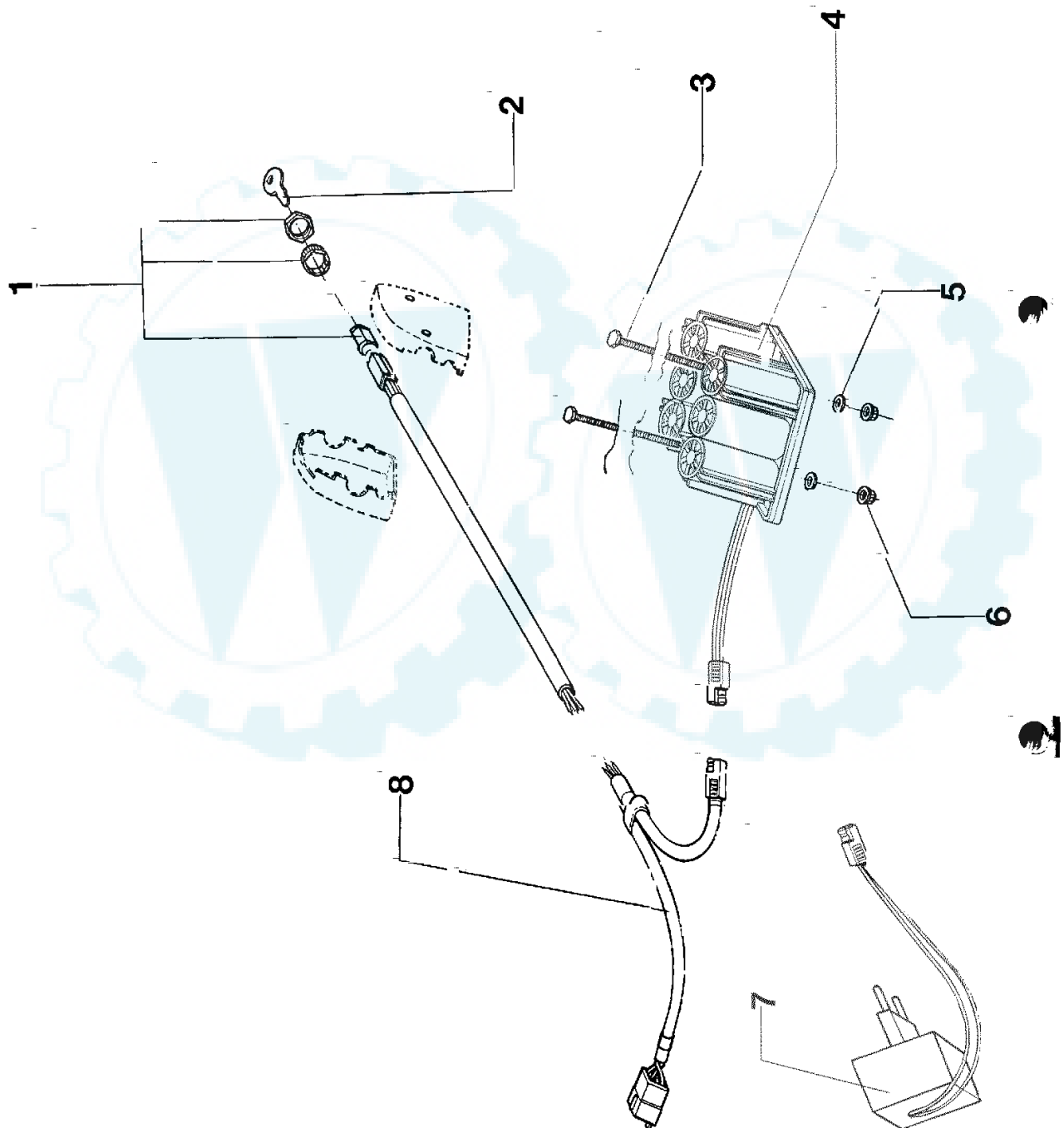

REF. N°	PART. N°	QTY	DESCRIZIONE	DESCRIPTION	DESCRIPTION	BESCHREIBUNG
1	P5030010	1	BLOCCETTO AVVIAMEN.	KEY SWITCH	INTERRUPTEUR	SCHLÜSSELSCHALTER
2	P5030011	2	CHIAVE AVVIAMENTO	KEY	CLAVETTE	SCHLÜSSEL
3	P1010077	2	VITE	SCREW	VIS	SCHRAUBE
4	P5030008	1	BATTERIA 12V	BATTERY 12V	BATTERIE 12V	BATTERIE 12V
5	P1020055	2	RONDELLA	WASHER	RONDELLE	SCHEIBE
6	1050002A1	2	DADO	NUT	ÉCROU	MUTTER
7	P5030009	1	CARICA BATTERIA	BATTERY CHARGER	CHARGEUR D'ACCUMULAT.	LADEGERÄT
7	P5030013	1	CARICA BATTERIA (GB)	BATTERY CHARGER (GB)	CHARGEUR D'ACCUM. (GB)	LADEGERÄT (GB)
8	P5030006	1	CAVO ELETTRICO	ELECTRIC CABLE	CÂBLE ÉLECTRIQUE	KABEL



Tav. 1

Vista generale
Complete machine
Vue d'ensemble
Gesamtansicht

